

REVISION HISTORY			
REV	DESCRIPTION	DATE	APPROVED

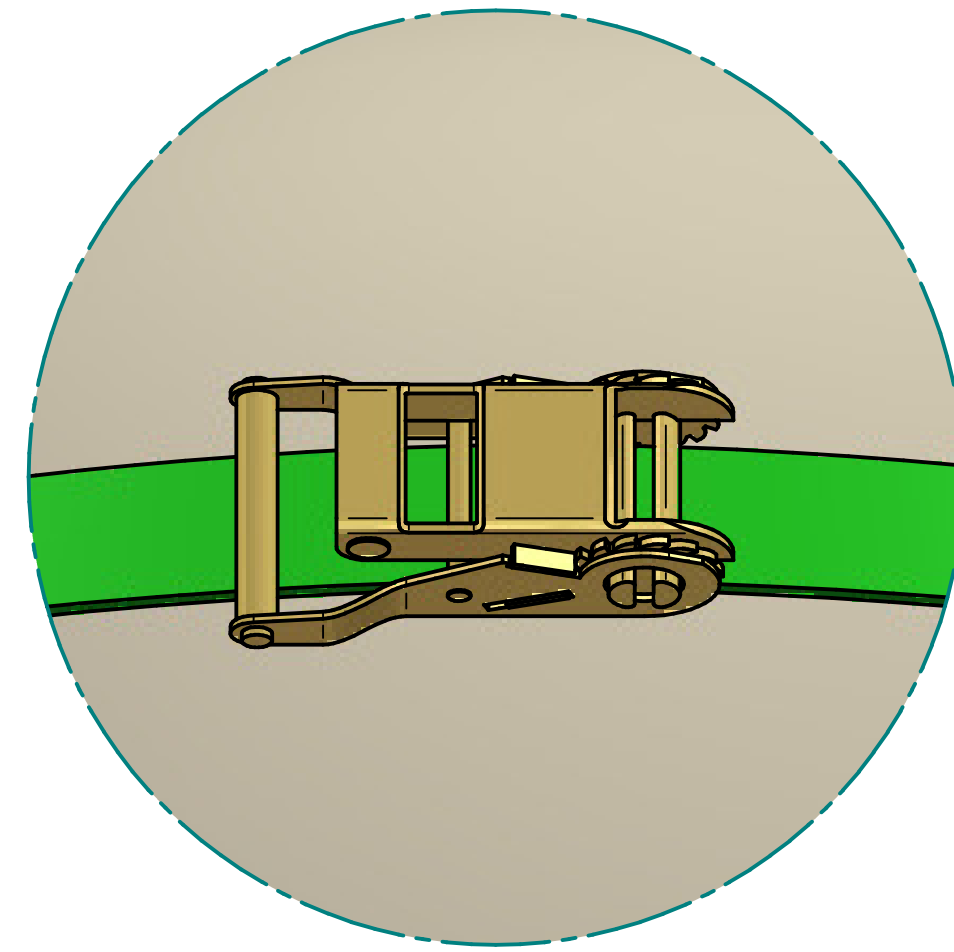

DETAIL A

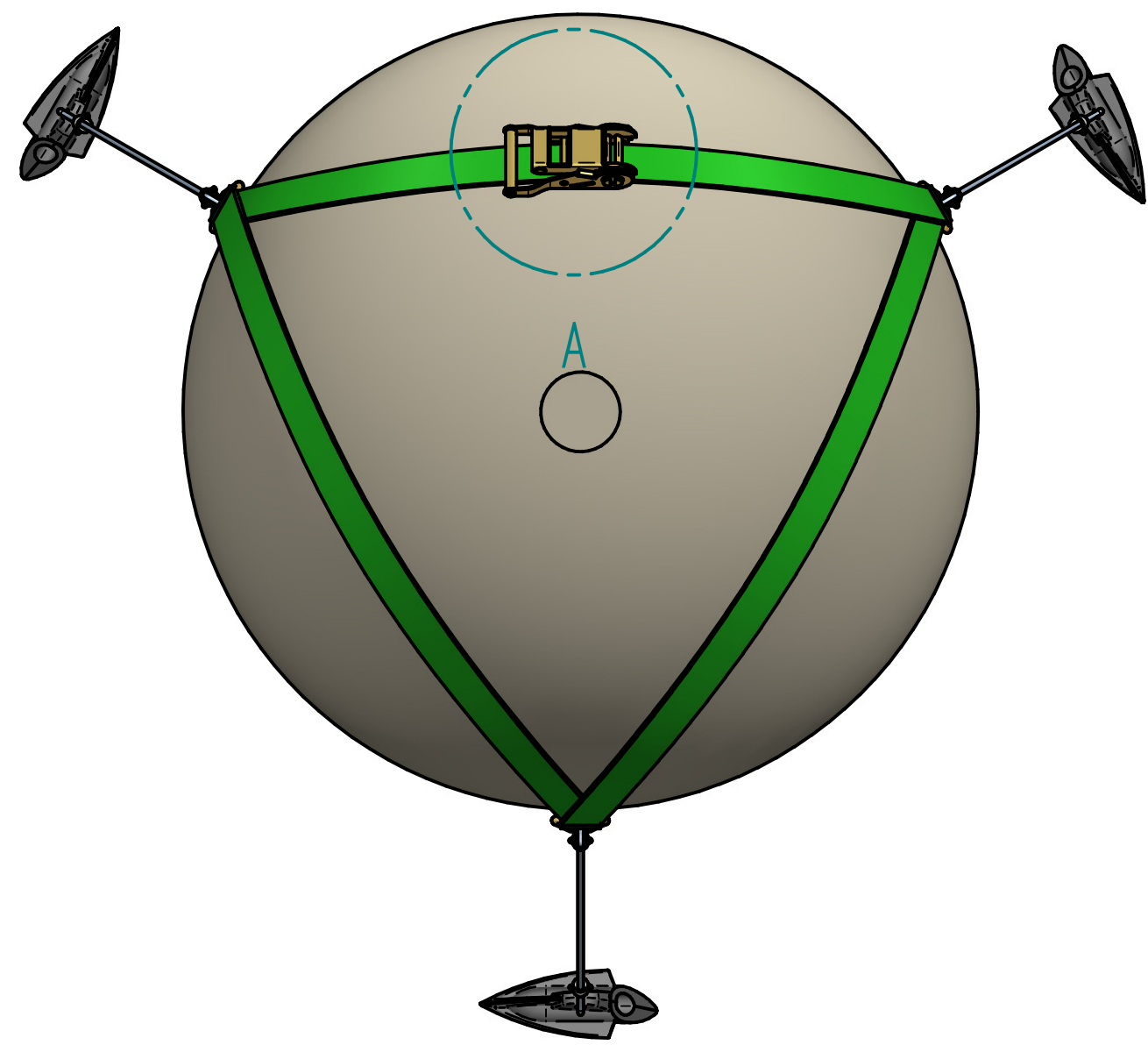
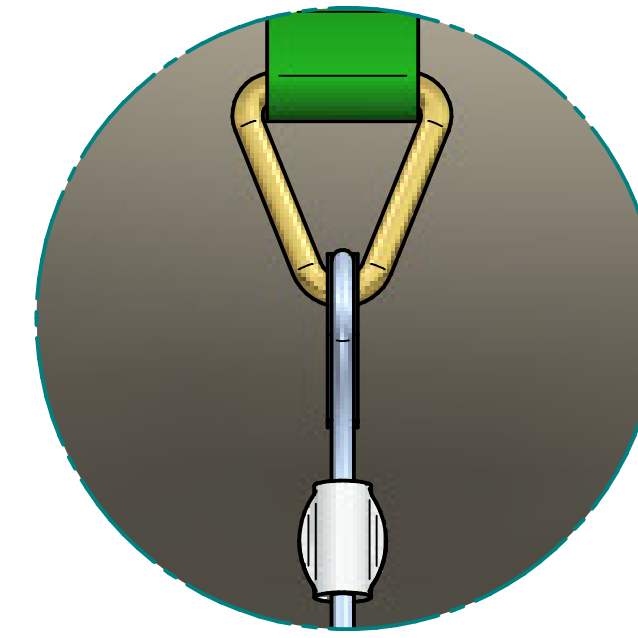

DETAIL B

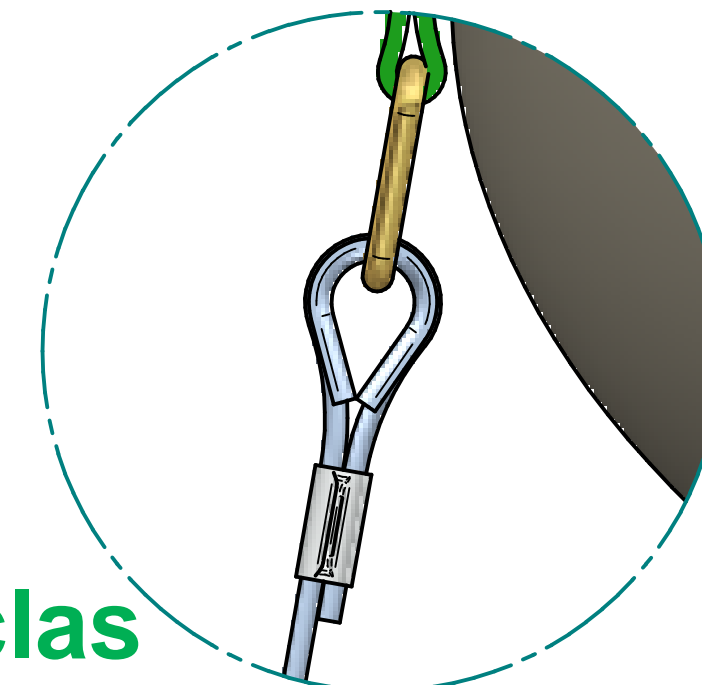

DETAIL D

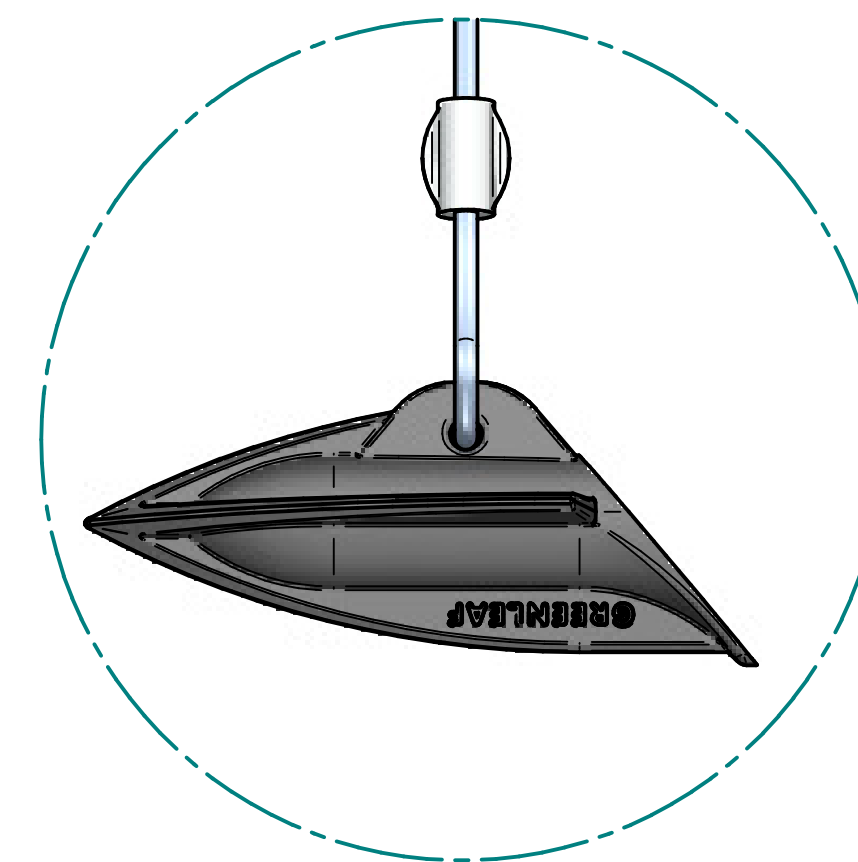

DETAIL C



Illustration of SASL strap and guy assembly positioned around tree root ball
 Ilustración del SSASLP60A la cincha instalado encima del cepellón con las anclas

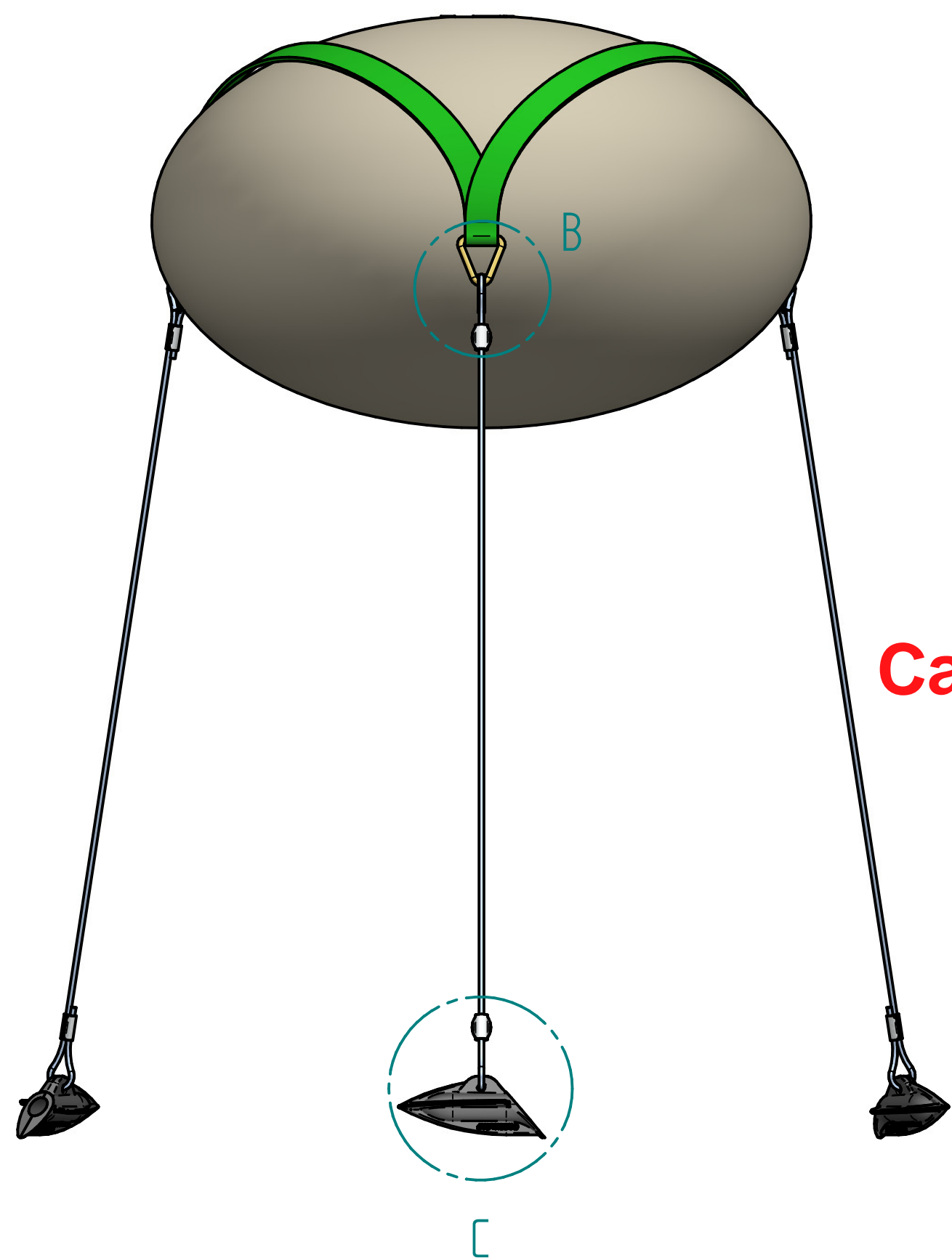

Cable de 60cm

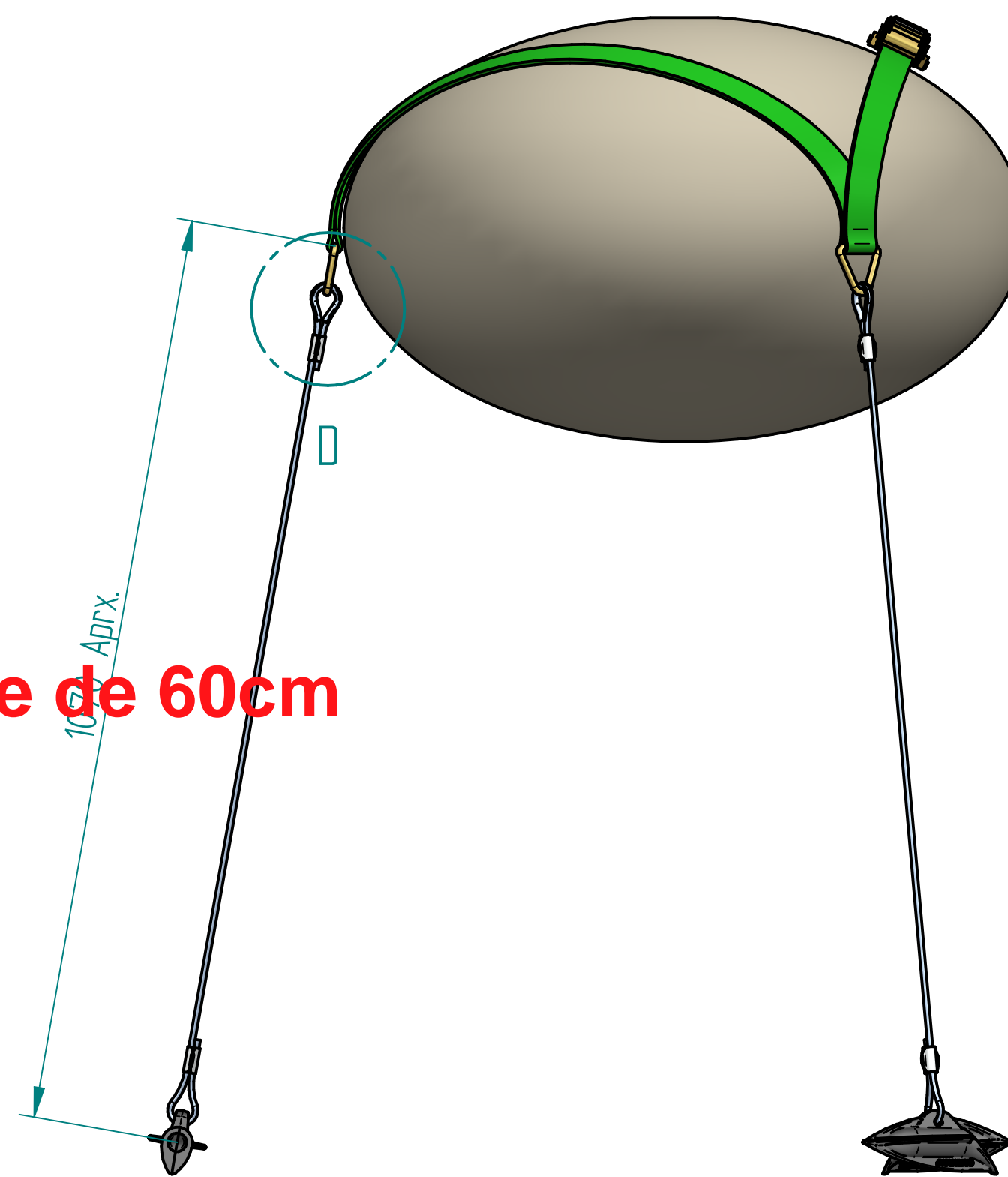

Greenleaf |

NAME	DATE	Greenleaf Urban tree and landscape products	
DRAWN	Adrian White	19/11/2010	3 Hayward Way, Ivyhouse Industrial Estate, Hastings, East Sussex TN35 4PL Tel: +44 (0)1424 717 797 Fax: +44 (0)1424 205 240 E-mail: enquiries@greenleaves.com Website: www.greenleaves.com
CHECKED			TITLE
ENG APPR			Stakes, Straps & Anchors
MGR APPR			SAS-LP Assembly Illustration
UNLESS OTHERWISE SPECIFIED DIMENSIONS ARE IN MILLIMETERS		SIZE	REV
ANGLES °XX°		A1	GRE-101118-DFT-001
2 PL ±XXX 3 PL ±XXXX		FILENAME:	SAS-LP_Assembly_Illustration.dft
SCALE:	WEIGHT:	SHEET 1 OF 1	